

A small icon showing a cross-section of a pitched roof with a solar panel mounted on it, enclosed in a red circle.

## Pitched roof systems

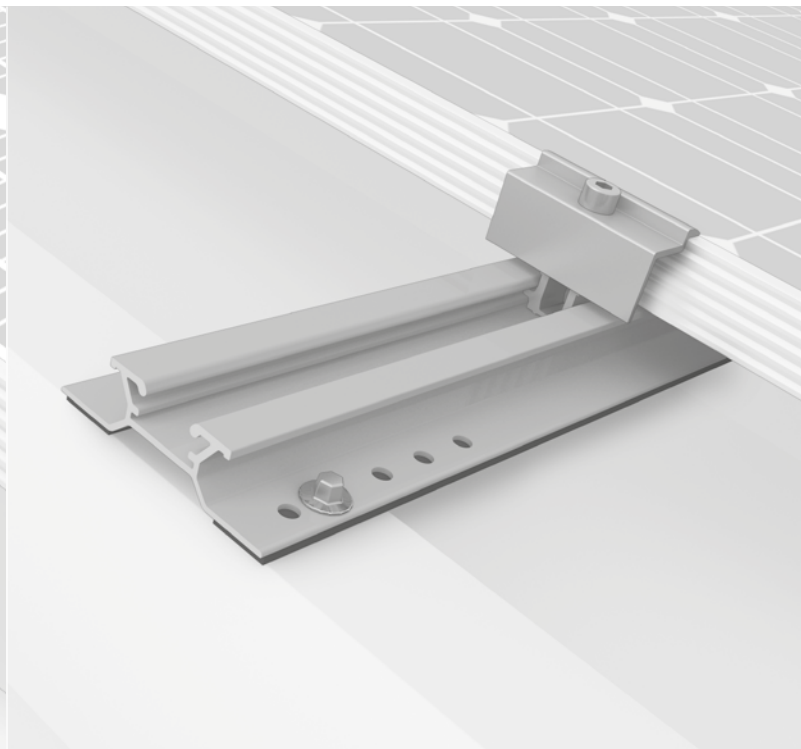

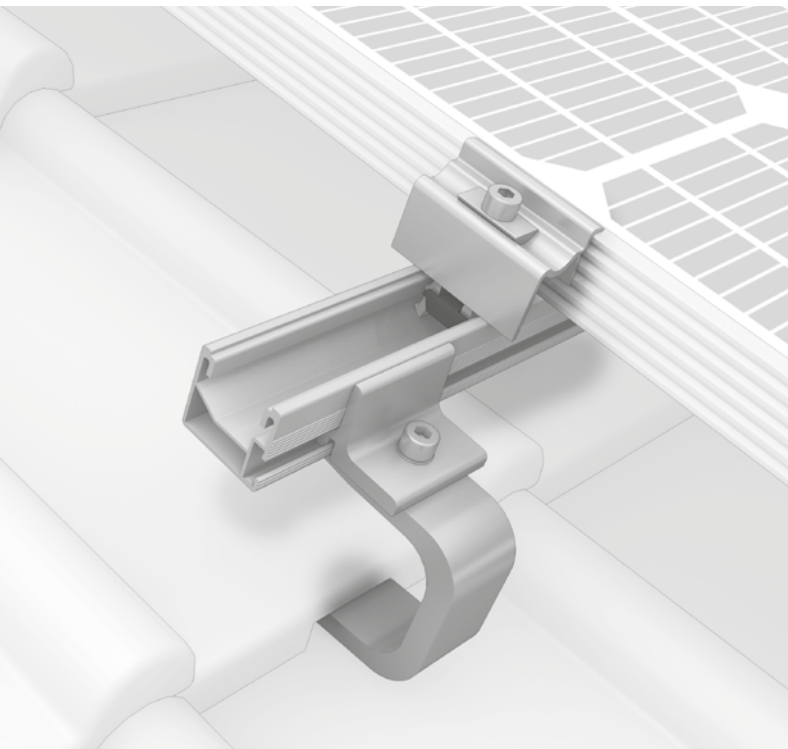

		Pantiles	Plain tile	Slate	Trapezoidal sheet metal	Sandwich panel	Corrugated sheet metal	Corrugated fibre cement	Standing seam roof
▶ SingleRail System	4	●	○	○	○	○	○	●	●
▶ SolidRail System	6	●	●	●	●	○	○	●	●
▶ Insertion System	8	●	○	○	○	○	○	●	○
▶ MiniRail System	10	○	○	○	●	●	○	○	○
▶ SpeedRail System	12	○	○	○	●	●	○	○	○
▶ MultiRail System	14	○	○	○	●	●	○	○	○
▶ S-Dome Small System	16	○	○	○	●	○	○	○	○
▶ Overview of roof fastenings	18								
▶ Accessories	22								

● Suitable    ○ Unsuitable

## Warranty

We offer a 12-year warranty on all K2 system components.  
[k2-systems.com/en/guarantee](https://k2-systems.com/en/guarantee)



## Statics and design loads

K2 mounting systems fulfil the calculation principles in accordance with Eurocode 1 and 9.

## Pallet delivery

Many mounting systems are delivered in pallets to save space and costs.

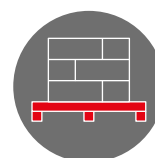

# SingleRail System

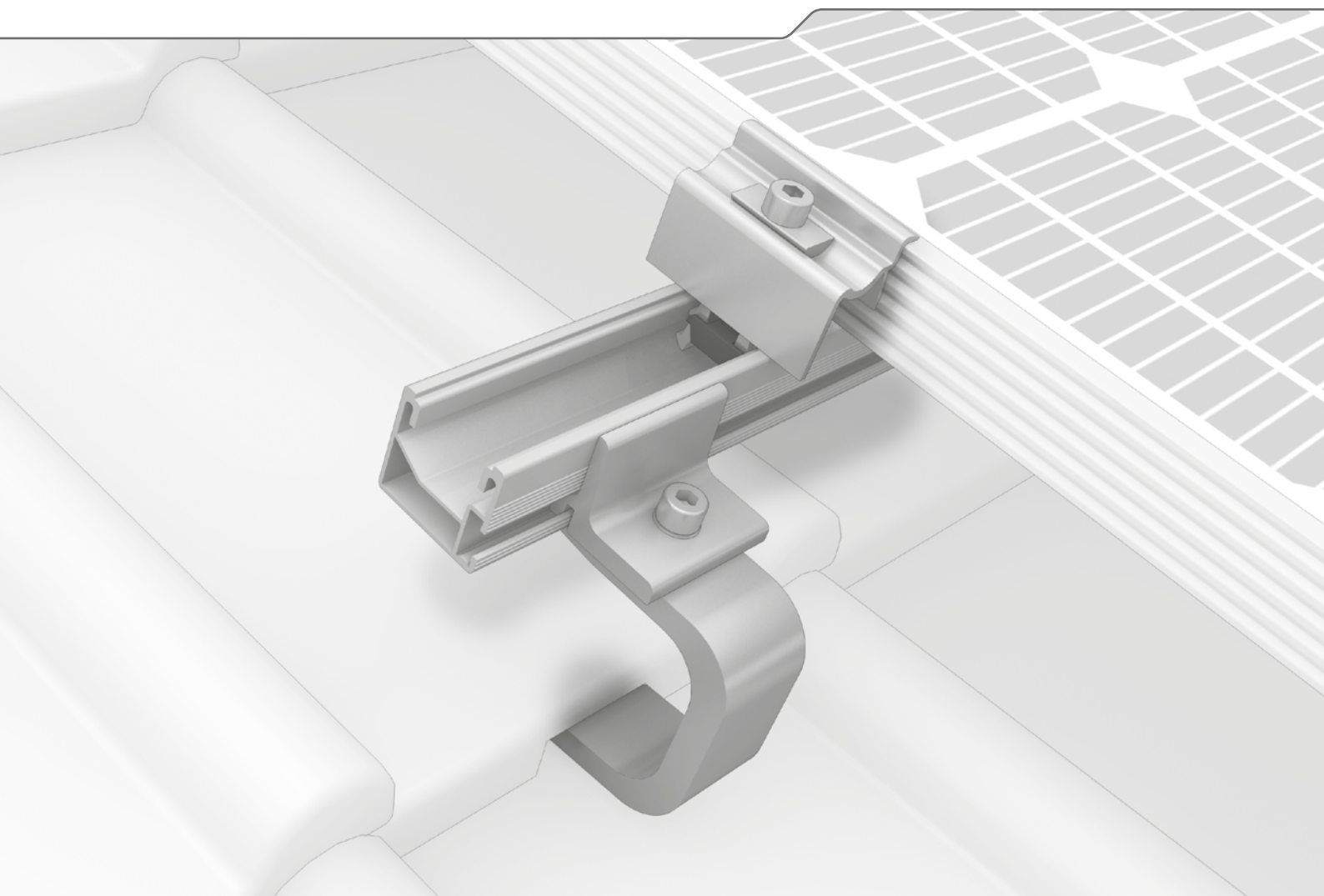

- ▶ Quick and low-cost with direct lateral connections to the rail without additional components including customised height adjustment
- ▶ Secure snap-in assembly – without needing to be screwed into the base plate
- ▶ The SingleRail in combination with CrossHook roof hooks is very durable and versatile



# Roof fastenings



### SingleHook 1.1

- ▶ For pantiles
- ▶ Easy height adjustment with slotted bore hole
- ▶ Also suitable for narrow rafters
- ▶ Connects directly to SingleRail

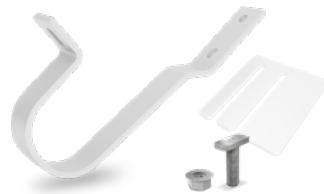

### SingleHook FT

- ▶ For flat tiles and pantiles
- ▶ Applicable on small rafters and independent from rafters
- ▶ Connects directly to SingleRail



### CrossHook 3S

- ▶ For pantiles
- ▶ 3 height adjustments in the base plate
- ▶ Also suitable for narrow rafters

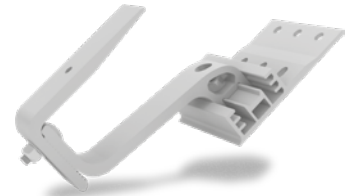

### CrossHook 4S

- ▶ For pantiles
- ▶ 3 height adjustments in the base plate
- ▶ Further height adjustment at the bracket itself.
- ▶ Also suitable for narrow rafters

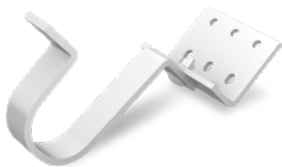

### SingleHook Vario

- ▶ For flat tiles and pantiles
- ▶ Height-adjustable at rail connection and battens
- ▶ Connects directly to SingleRail



### L-Adapter SR

- ▶ Adapter for special applications
- ▶ Compatible with SingleRail

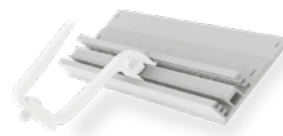

### CrossBoard

- ▶ The easy solution for noggings, skylights etc.
- ▶ Complements CrossHook 3S and 4S



### Hanger bolts SR

- ▶ For corrugated fibre cement roofing with wooden substructures
- ▶ With building approval

## Technical data

	SingleRail 36	SingleRail 50	SingleRail 63
Figure			
Material	Aluminium (EN AW-6063 T66)		
W = width [mm]	39.4	39	47
H = height [mm]	36	50	63
Lengths [m]	2.10/3.15/4.15/6.10	6.10	6.10
Weight [kg/m]	0.76	1.0	1.51
Cross-bracing with	SingleRail or SolidRail		

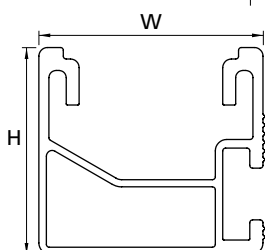

**For heavy loads and large spans!**

### Roof fastenings

You will find detailed technical data on our roof fastenings starting on page 18.

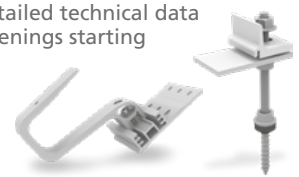

# SolidRail System

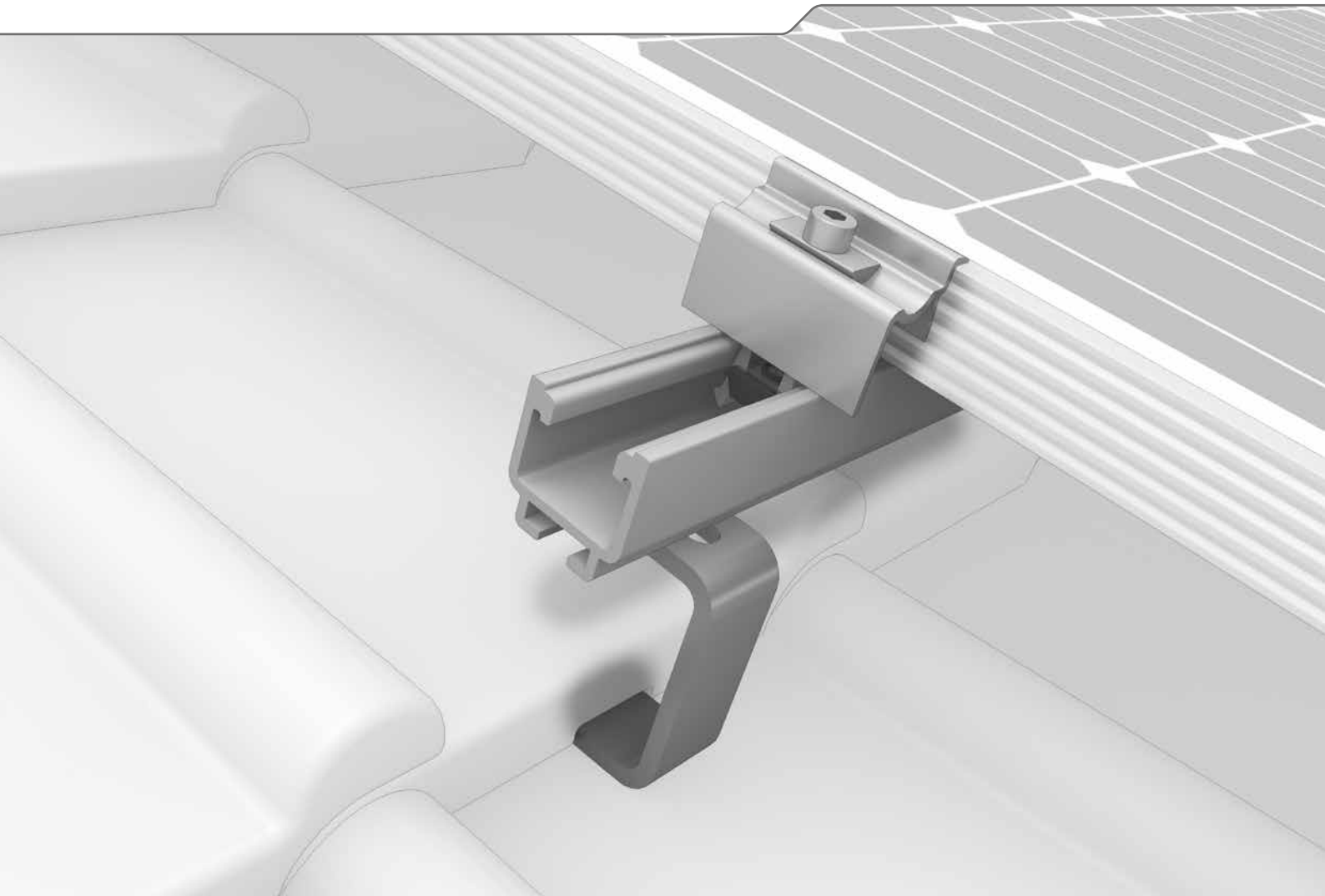

- ▶ Comprehensive range of mounting rails for varying load profiles
- ▶ Robust and structurally proven
- ▶ High flexibility for a diverse range of widths



## Roof fastenings



### Roof hook for pantiles

- ▶ Various sizes
- ▶ Solid stainless steel design

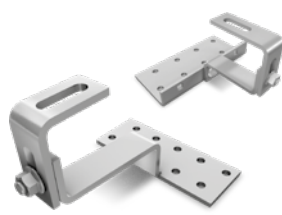

### Vario 1 and 2 roof hooks

- ▶ For pantiles
- ▶ Height-adjustable under bracket and at battens



### Roof hook for plain tile roofing

Also for double roofing



### Roof hook for slate roofing

Three boreholes for a secure fit



### Roof hook for Coppo roofing

- ▶ Height-adjustable under bracket
- ▶ Flexible placement on rafters



### Hanger bolts

- ▶ For corrugated fibre cement or corrugated sheet roofing with wooden substructure
- ▶ Custom height adjustment



### Solar fastener

- ▶ For trapezoidal sheet metal, corrugated sheet metal, or corrugated fibre cement roofing
- ▶ For steel, timber or concrete

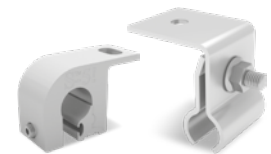

### Standing seam clamps

Seam metal clamps for popular standing seam roofs such as Kalzip or Rib-Roof

## Technical data

	UltraLight 32	Light 37	Medium 42	Alpine 60
Figure				
Material	Aluminium (EN AW-6063 T66)			
W = width [mm]	39	39	41	41
H = height [mm]	32	37	42	60
Lengths [m]	2.10/3.15/4.15/6.10			
Weight [kg/m]	0.7	0.85	1.3	1.7
Cross-bracing with	SingleRail			

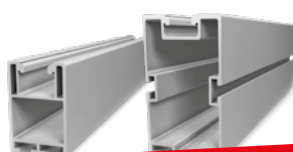
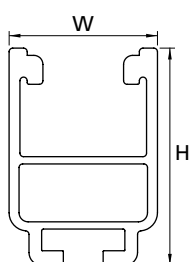

**SolidRail LS85 and XL140:**  
For heavy loads across large widths!

### Roof fastenings

You will find detailed technical data on our roof fastenings starting on page 18.

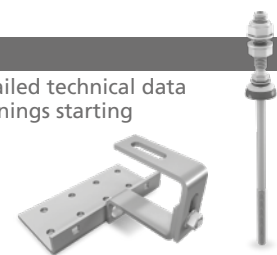

# Insertion System

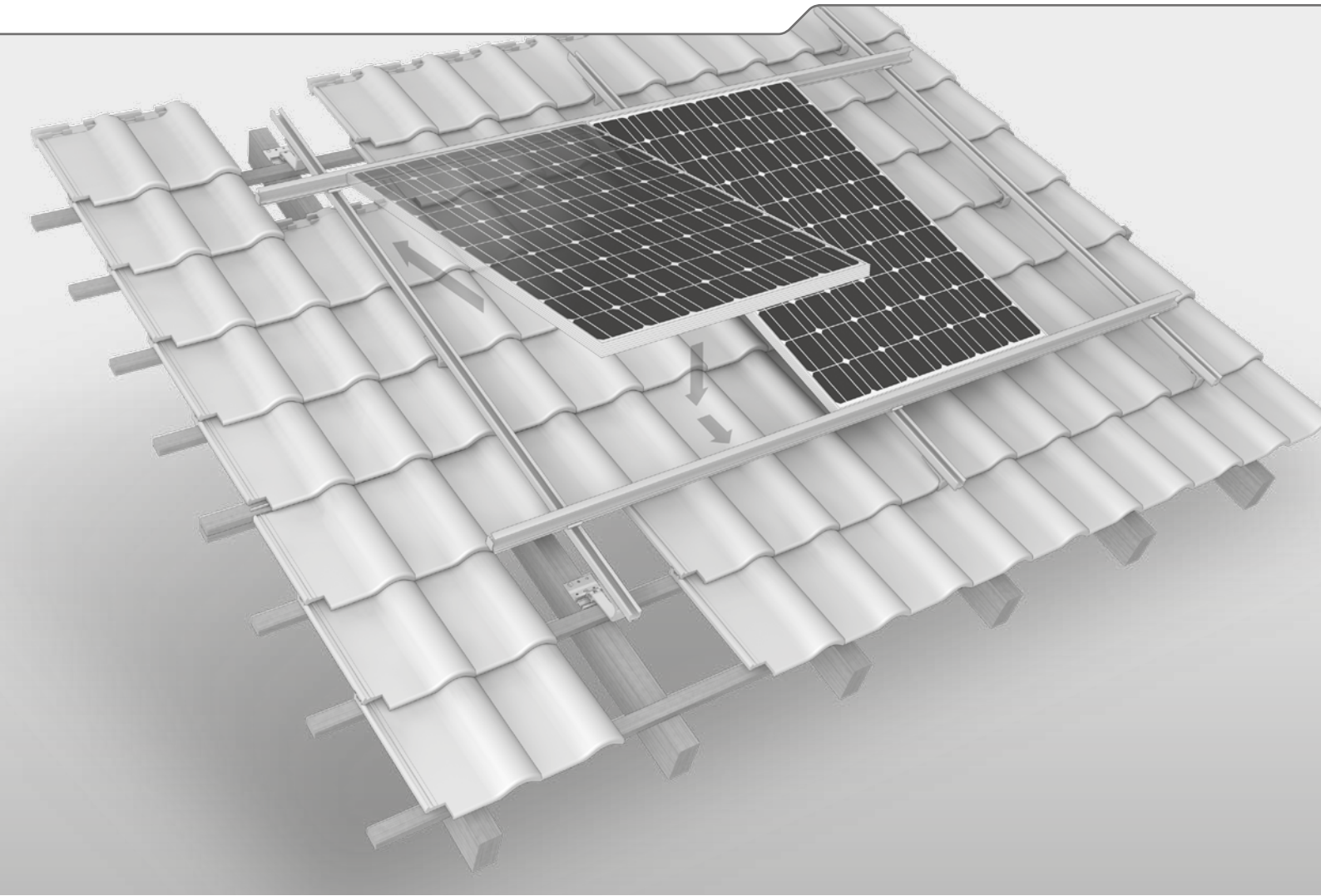

- ▶ Without having to apply clamps eliminates the need for assistance ensuring lightning-fast installation
- ▶ Easy to assemble with few components and without special tools
- ▶ Sleek design with continuous closed surface adds further robustness
- ▶ Insertion profile provides additional frame reinforcement



In cooperation with  
**solarteam** ● 



## Components

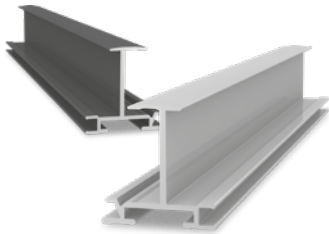

### Insertion rails

- ▶ Intelligent solution for efficient module installation
- ▶ Seals surface
- ▶ Available in black



### Cross connector

- ▶ Fixation for insertion rail on SolidRail
- ▶ Simple mounting

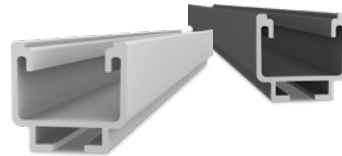

### SolidRail

- ▶ Robust mounting rail
- ▶ Different load conditions
- ▶ For large spans
- ▶ Available in black

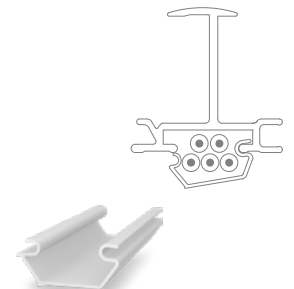

### Cable management

- ▶ Quick cable connection beneath the insertion rail
- ▶ Up to 5 cables

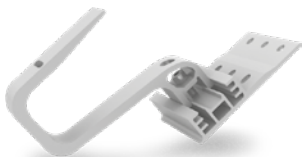

### CrossHook 3S+/4S+

- ▶ Height-adjustable and laterally adjustable
- ▶ Also suitable for narrow rafters



### Hanger bolt with adapter

For corrugated fibre cement roofing with wooden substructures

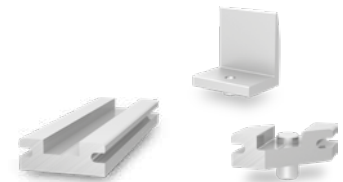

### Accessories

- ▶ Connector insertion rail
- ▶ Side stopper
- ▶ Horizontal end bracket

## Technical data

	Insertion system
Scope of application	Pitched roofs with pan tiles or corrugated fibre cement
Fastening type / roof connection	Roof hooks or hanger bolts
Module frame heights (H)	<ul style="list-style-type: none"> <li>▶ 35 mm</li> <li>▶ 40 mm</li> <li>▶ More heights on request</li> </ul>
Requirements	7 mm spacing between insertion rails
Module orientation	Landscape and portrait
Material	<ul style="list-style-type: none"> <li>▶ Mounting rails and cross connector: Aluminium EN AW-6063 T66</li> <li>▶ Components: stainless steel (1.4301) A2-70</li> </ul>
SolidRail lengths [m]	Aluminium mill finish: 4.15 and 6.10 Black anodised: 6.10
Insertion rail lengths [m]	Aluminium mill finish: 5.10 Black anodised: 5.10

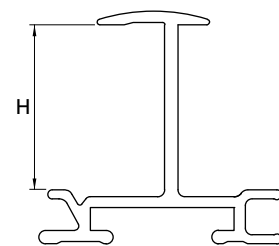

### Roof fastenings

You will find detailed technical data on our roof fastenings starting on page 18.

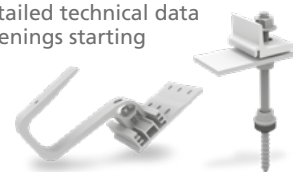

# MiniRail System

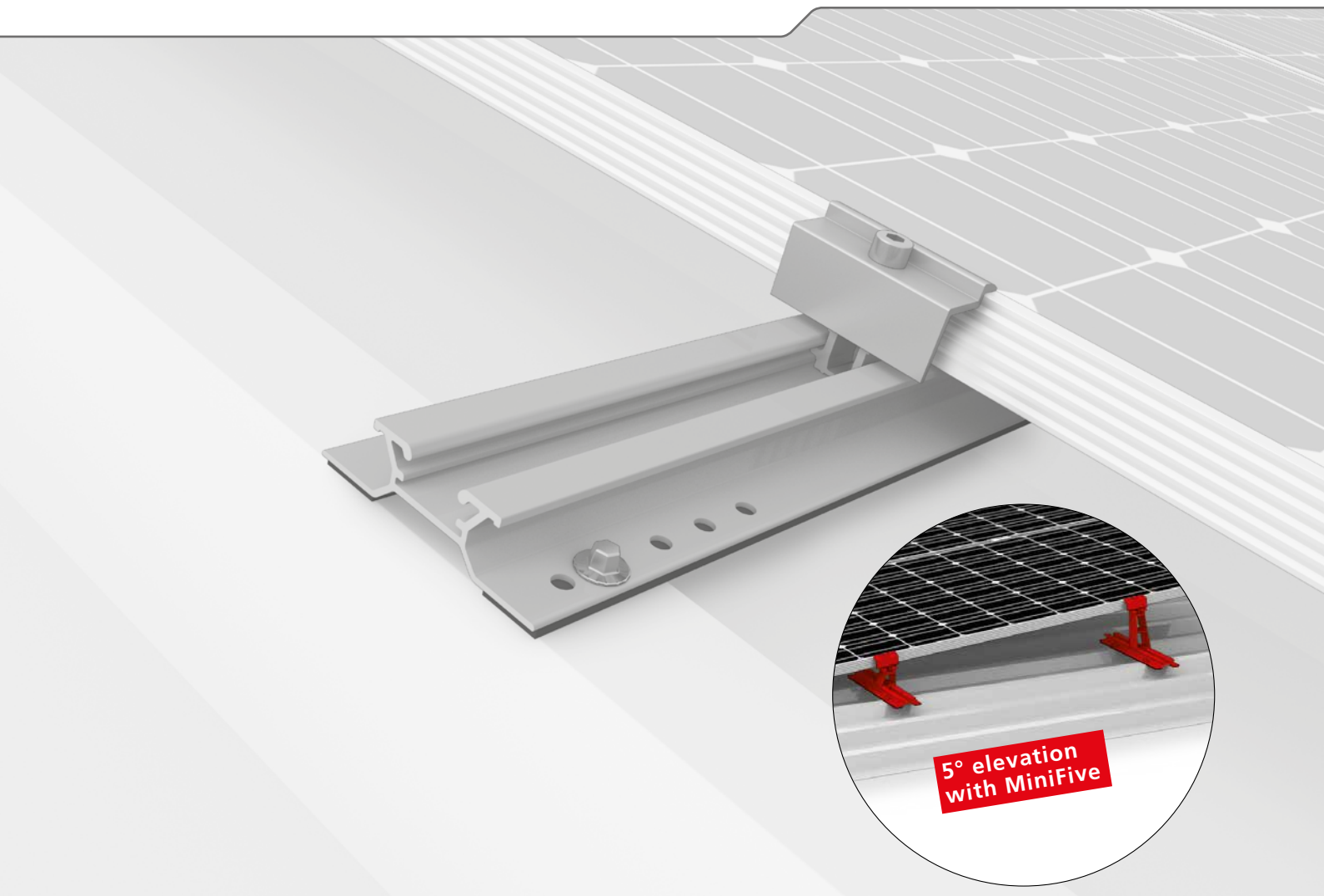

- ▶ Innovative and statically optimised short rail system that is quick and easy to mount
- ▶ Universal module clamps and suitable for portrait and landscape orientation
- ▶ 5° elevation with MiniFive: significantly more output thanks to improved ventilation and optimised module angle
- ▶ Optimised for storage and transport

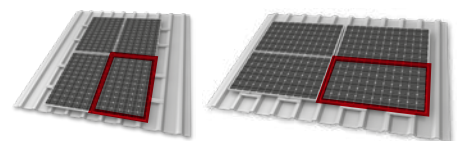
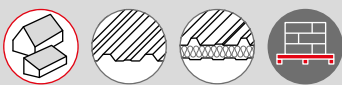

The MiniRail System allows portrait and landscape mounting in the form of grid mounting thanks to the universal module clamps, which are rotatable by 90°.

## Components



### MiniRail

Landscape and portrait mounting with MiniClamp MC/EC



### MiniClamp MC/EC 30 - 50 mm

- ▶ Universal module clamp
- ▶ Clamp is rotatable



### Self-tapping screws

- ▶ Included in MiniRail MC/EC set
- ▶ With sealing washers



### MiniFive front and end

- ▶ Single-sided easy elevation with insertable supporting element
- ▶ Improved ventilation and higher yield
- ▶ Optimised module angle

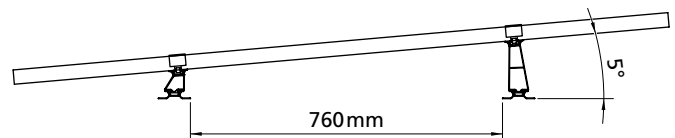

## Technical data

MiniRail System	
Scope of application	Pitched roofs with trapezoidal sheet metal or sandwich panels Roof inclination: 5-75°
Fastening type / roof fixture	Screws in roofing with self-tapping thin sheet screws
Requirements	<ul style="list-style-type: none"> <li>▶ Sheet thickness: <math>\geq 0.5</math> mm (steel and aluminium)</li> <li>▶ Sandwich panel: Approval from manufacturer required</li> <li>▶ Crest width: At least 22 mm *</li> <li>▶ Crest spacing: 101 - 350 mm depending on crest width</li> <li>▶ Flush area surrounding the bore hole: <math>\varnothing \geq 20</math> mm</li> <li>▶ Module frame height: 30 - 50 mm</li> </ul>
Module orientation	Vertical or horizontal
Material	Aluminium (EN AW-6063 T66/ EN AW-6082 T6); EPDM
Dimensions MiniRail W x H x L [mm]	78.2 x 23 x 385
Elevation with MiniFive	approx. 5°

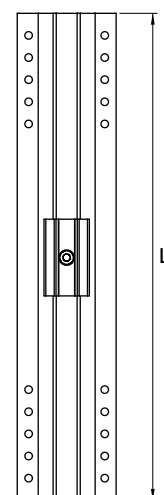
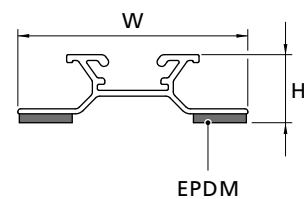

\* The project-specific minimum high crest width dimension can be found in the Base On report.

# SpeedRail System

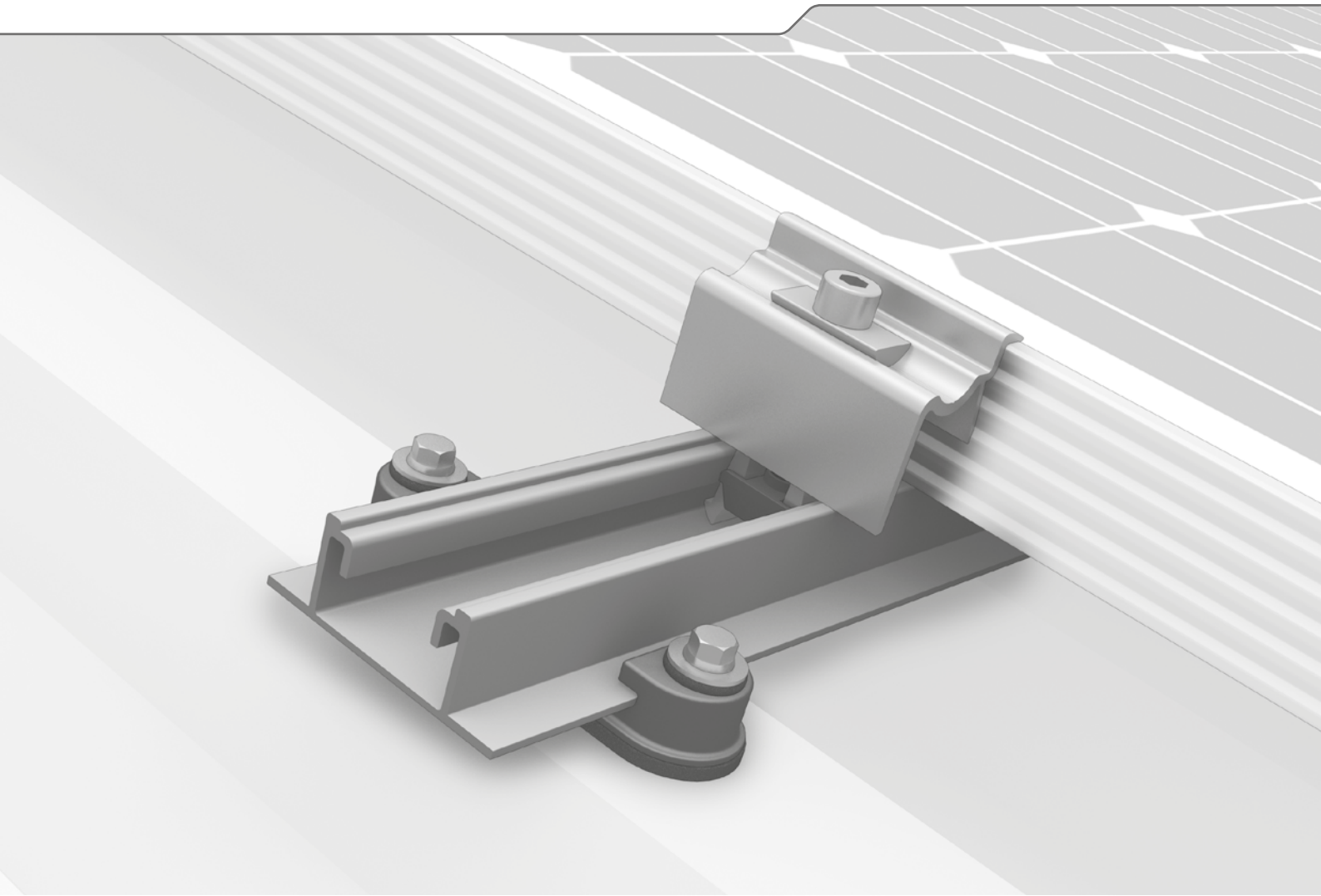

- ▶ The proven long rail system for trapezoidal sheet applications as well as floating suspension with controlled thermal linear expansion
- ▶ Our most popular system – over 1 GW installed worldwide
- ▶ All-rounder with only 4 installation steps – also suitable for high loads



## Components

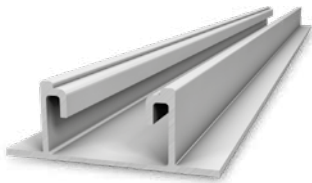

### SpeedRail

- ▶ Mounting rail with easy insertion mounting into SpeedClips
- ▶ Various lengths available



### SpeedClip

- ▶ Mounting brackets for SpeedRail
- ▶ Simple insertion feature
- ▶ Glass fibre reinforced polyamide with EPDM seals
- ▶ Fastened with self-drilling screws for trapezoidal sheet metal

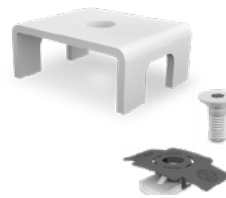

### SpeedLock

- ▶ Mounting lock for SpeedRail in case of thermal expansion
- ▶ In a set with MK2 slot nut and stainless steel screw



### SpeedConnector

- ▶ Rail connector for SpeedRail
- ▶ Three boreholes for flexible mounting
- ▶ In a set with countersunk screws

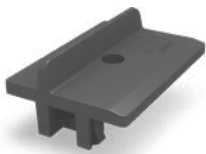

### AddOn

- ▶ For grid mounting and ensures easy shared-rail mounting
- ▶ Glass fibre reinforced polyamide

## Technical data

SpeedRail / SpeedClip	
Scope of application	Trapezoidal sheet roof
Fastening type / roof fixture	Insertion mounting into SpeedClips and screws in the roofing
Material	<ul style="list-style-type: none"> <li>▶ SpeedRail: Aluminium (EN AW-6063 T66; 0.64kg/m)</li> <li>▶ SpeedClip: Glass fibre reinforced polyamide with EPDM</li> </ul>
SpeedRail dimensions W = width [mm] H = height [mm] L = lengths [m]	63 22.5, 2.1 / 3.15 / 4.15 / 6.1
SpeedClip dimensions	See drawing
Cross-bracing with	SingleRail or SolidRail

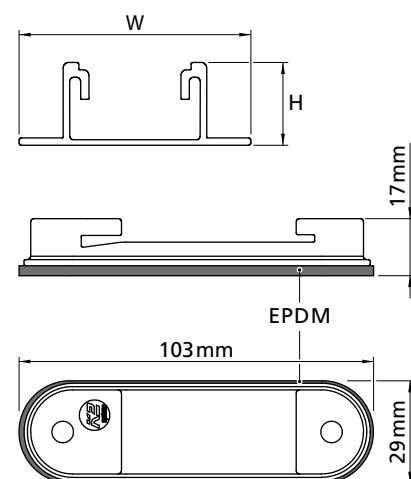

# MultiRail System

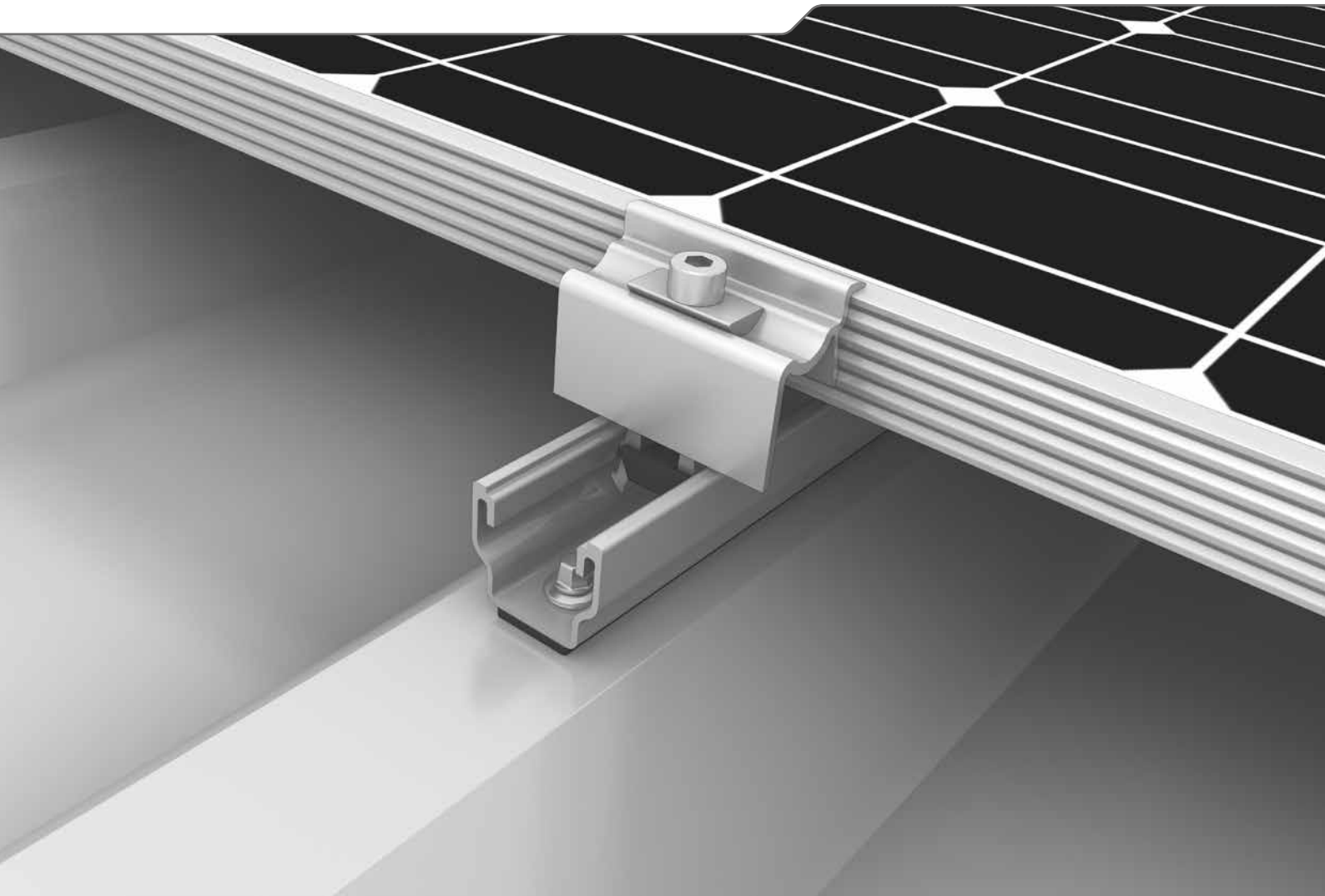

- ▶ Easy and proven – as a short rail or a flexible component in various lengths
- ▶ Quick planning with less material and greater effectiveness
- ▶ Compact shipping dimensions and entirely palletised

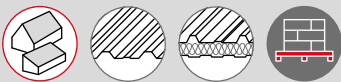

## MultiRail Versions

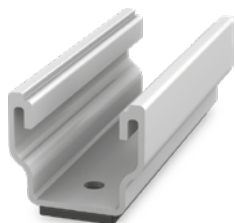

### MultiRail 10

- ▶ Length 100 mm
- ▶ Horizontal module orientation

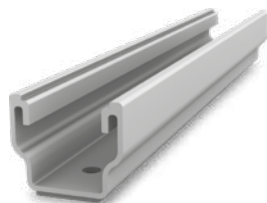

### MultiRail 25/4

- ▶ Length 250 mm
- ▶ For more flexibility and high load demands at horizontal module orientation

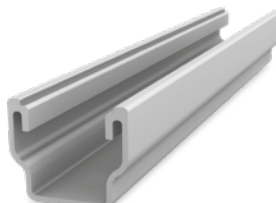

### MultiRail 4.20

- ▶ Length 4 200 mm
- ▶ Long rail for cutting to customised sizes
- ▶ Without EPDM seal; to be fastened manually with adhesive

## Technical data

	MultiRail 10, 25/4, 4.20
Scope of application	Pitched roofs, 5-75°, with trapezoidal sheet metal or sandwich panel
Fastening type / roof fixture	Fastened with self-tapping sheet screws
Requirements	<ul style="list-style-type: none"> <li>▶ Sheet thickness: <math>\geq 0.5</math> mm (steel and aluminium)</li> <li>▶ Sandwich panel: approval from manufacturer required</li> <li>▶ Crest width: at least 22 mm</li> <li>▶ Maximum crest width: independent of crest distance</li> </ul>
Material	Aluminium (EN AW-6063 T66); EPDM
W = width [mm]	39
H = height [mm]	35
L = rail length [mm]	<ul style="list-style-type: none"> <li>▶ MultiRail 10: 100</li> <li>▶ MultiRail 25/4: 250</li> <li>▶ MultiRail 4.20: 4200</li> </ul>
Cross-bracing with	SingleRail

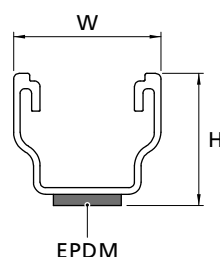

# S-Dome Small System

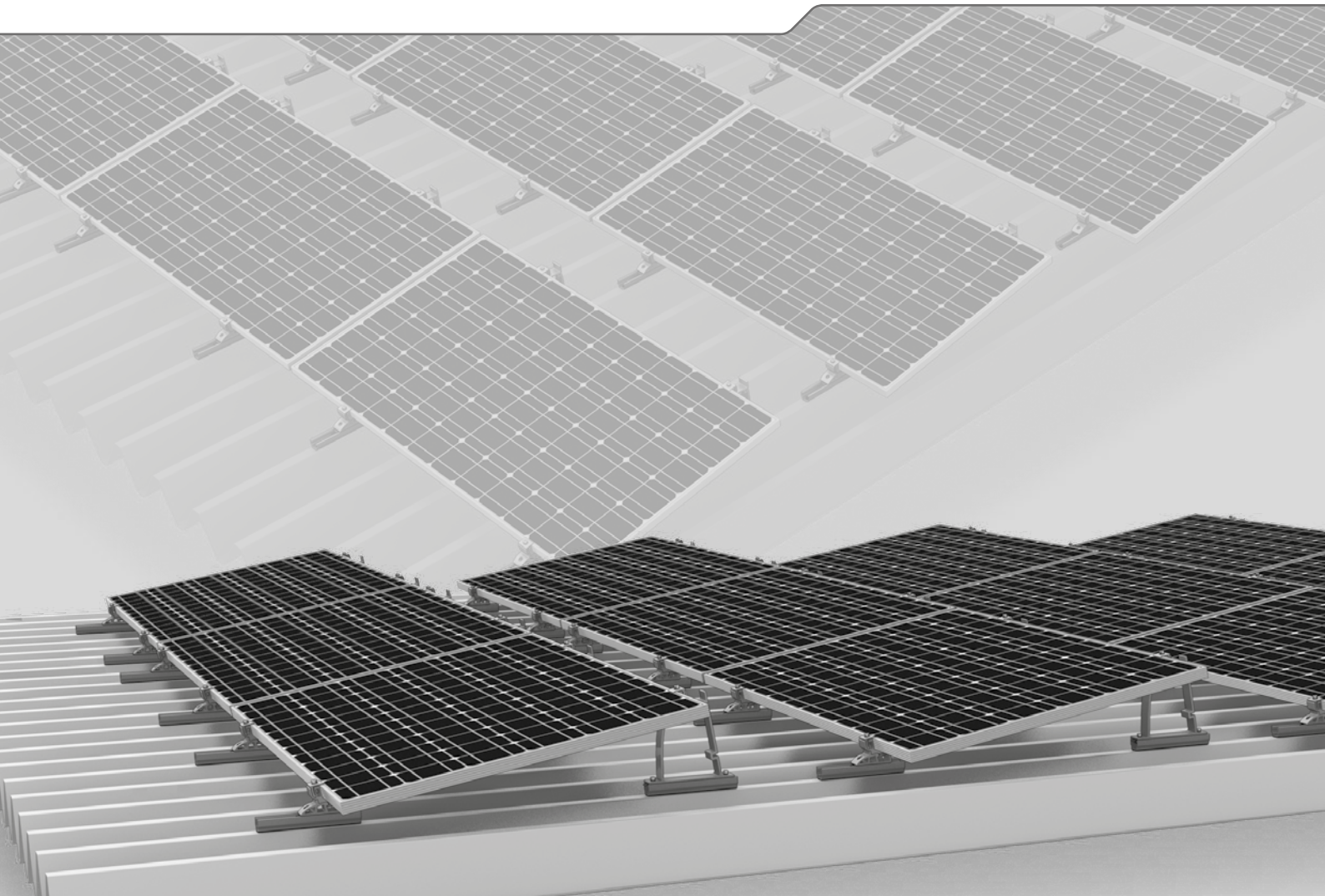

- ▶ For a roof inclination of up to 15° on trapezoidal sheet metal
- ▶ Economical in terms of materials and transportation; clever connections and strong holding power
- ▶ The perfect combination of the all-round MultiRail component and load-optimised, slim elevations





## Components



**Dome S1000 Small**  
Narrow elevation module support element



**Dome SD Small**  
Narrow module support element

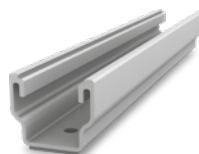

**MultiRail 25/4**  

- ▶ Length 250 mm
- ▶ With four boreholes for roofs with up to 15° inclination

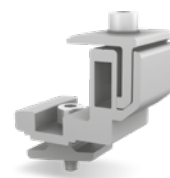

**FlexClamp Small**  

- ▶ For clamping on the long side of module
- ▶ Height adjustable

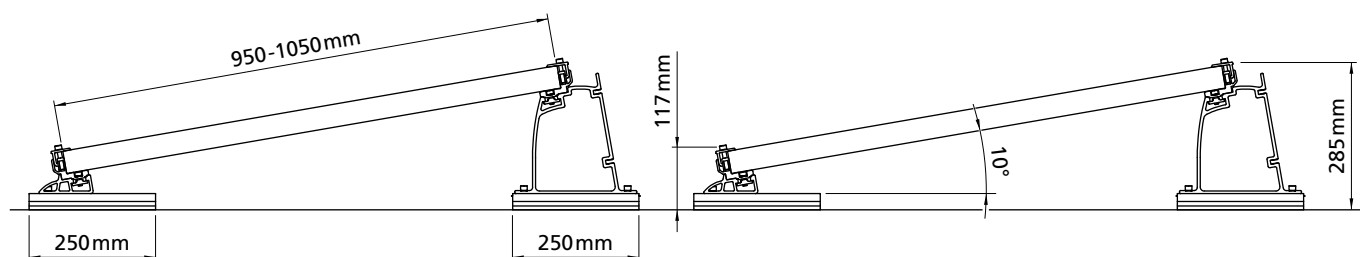

## Technical data

	S-Dome Small
Scope of application	Flat or pitched roofs $\leq 15^\circ$ with trapezoidal sheet metal roofing
Fastening type / roof fixture	Attached with drilling screws in trapezoidal sheets, parallel to raised crests
Requirements	<ul style="list-style-type: none"> <li>▶ Sheet thickness for aluminium/steel: min. 0.5 mm</li> <li>▶ Tensile strength for aluminium: 165 N/mm<sup>2</sup></li> <li>▶ Tensile strength for steel: acc. to approval min. S235 in acc. with DIN EN 10025-1</li> <li>▶ Crest width: min. 22 mm</li> <li>▶ Crest spacing: independent of crest distance</li> </ul>
Inclination angle	10°
Material	<ul style="list-style-type: none"> <li>▶ Mounting rails, Dome SD Small, Dome S1000 Small, FlexClamp Small: Aluminium (EN AW-6063 T66/ EN AW-6082 T6); EPDM</li> <li>▶ Small parts: Stainless steel (1.4301) A2</li> </ul>

# Overview of roof fastenings

## CrossHooks and SingleHooks for CrossRail and SingleRail

Type / image	Base plate width [W]	Height under bracket [H <sub>1</sub> ] Bracket height [H <sub>2</sub> ] Total height [H <sub>3</sub> ]	Bracket depth [D]	Item no.
<b>CrossHook 3S/3S+</b> 	100 mm	▶ 40/47/54 mm ▶ 56 mm ▶ approx. 123/130/137 mm	83 mm	2000133
<b>CrossHook 4S/4S+</b> 	100 mm	▶ 40/47/54 mm ▶ 55 - 85 mm ▶ 120.5 - 165 mm	83 mm	2000466
<b>SingleHook 1.1 *</b> 	100 mm	▶ 47.1 mm ▶ 56 mm ▶ 162.9 mm	83 mm	2001928
<b>CrossBoard für CrossHook 3S/4S</b> 	2100 mm	▶ 40/47/54 mm ▶ 56/55 - 85 mm ▶ approx. 123/130/137/ 120.5 - 165 mm	83 mm	2001972
<b>CrossHook 2G</b> 	100 mm	▶ 40/47/54 mm ▶ No spacing ▶ 89.2 mm	-	2000636
<b>CrossHook 2 (BS EN 490)</b> 	150 mm	▶ 44 mm ▶ 46 mm ▶ 100 mm	116 mm	1004900
<b>SingleHook FT</b> 	30 mm	▶ 16 mm ▶ 68 mm ▶ 141 mm	120 mm	2002568
<b>SingleHook Vario</b> 	100 mm	▶ 45 - 65 mm ▶ 68 mm ▶ 172 - 192 mm	110 mm	2002651

Dimension drawing for CrossHook

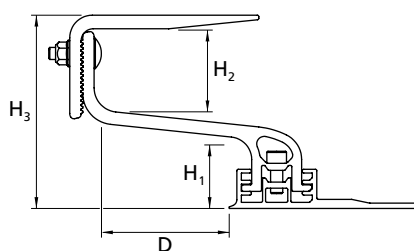



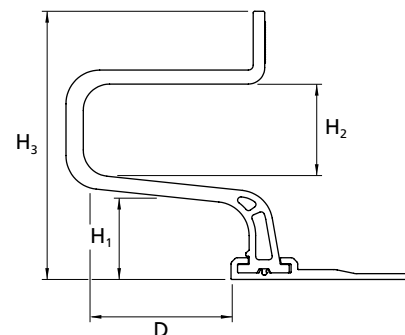









Dimension drawing for SingleHook

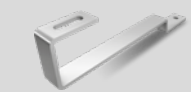

\* Suitable exclusively for SingleRail

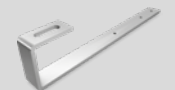
## Stainless steel roof hooks for SolidRail

Type /Figure	Base plate [a x b x c]	Bracket [d x e]	Bracket [H <sub>1</sub> ]/[H <sub>2</sub> ]	Total height approx. [H <sub>3</sub> ]	Bracket depth [D]	Item no.
<b>Pantiles</b>  	150 x 60 x 5 mm	30 x 6 mm	47/65 mm	134 mm	98 mm	1000001
	180 x 80 x 4 mm	35 x 6 mm	38/69 mm	124 mm	91 mm	1000096
	180 x 80 x 4 mm	35 x 6 mm	38/89 mm	150 mm	91 mm	1000653
	180 x 80 x 5 mm	40 x 8 mm	47/55 mm	121 mm	87 mm	1000764
<b>Vario 1</b>  	150 x 60 x 5 mm	30 x 6 mm	43/41 - 71 mm	112-145 mm	95 mm	1000125
<b>Vario 2</b>  	140 x 55 x 5 mm	30 x 6 mm	49 - 57/41 - 69 mm	108-137 mm	94 mm	1000107
<b>Plain tile</b>  	40 x 50 mm	40 x 6 mm	33/62 mm	122 mm	189 mm	1000214
<b>Plain tile, double roofing</b>  	150 x 45 mm	150 x 60 mm	33/66 mm	103 mm	235 mm	1000074
<b>Slate roofing</b>  	40 x 250 mm	40 x 65 mm	-/60 mm	72 mm	72 mm	1000373
<b>Coppo</b>  	150 x 60 x 5 mm	30 x 5 mm	18/88 - 118 mm	123-153 mm	120 mm	1001068

### Dimension drawing

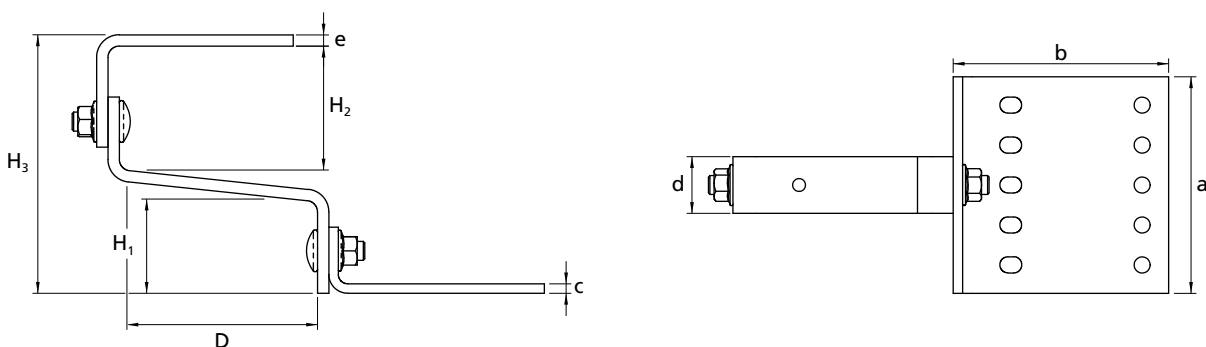

# Overview of roof fastenings

## Hanger bolts

### For timber substructures

For fastening the K2 SolidRail, SingleRail and CrossRail mounting rails on roofs with corrugated fibre cement or sheet metal on timber substructures. The K2 hanger bolts are equipped with an extra-long metric thread for installation height adjustment. Hanger bolts are outfitted with a pre-mounted adapter plate.

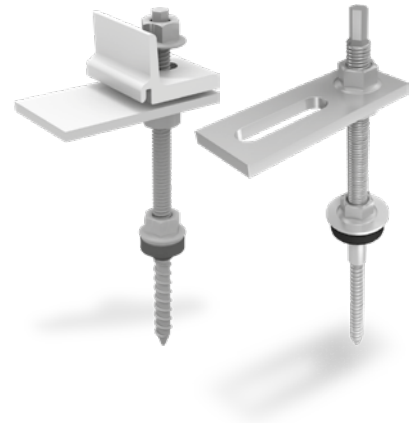
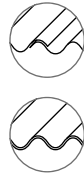

### CrossRail / SingleRail Hanger Bolts

Type	Item number
M10×180, hexagonal SW 7 mm	1006166
M10×200, hexagonal SW 7 mm	1006167
M10×250, hexagonal SW 7 mm	1006168
M12×200, hexagonal SW 9 mm	1006169
M12×250, hexagonal SW 9 mm	1006170
M12×300, hexagonal SW 9 mm	1006171
M12×350, hexagonal SW 9 mm	1006172
M12×400, hexagonal SW 9 mm	1006173

### SolidRail Hanger Bolt

Type	Item number
M10×180, hexagonal SW 7 mm	2000120
M10×200, hexagonal SW 7 mm	2000121
M10×250, hexagonal SW 7 mm	2000122
M12×200, hexagonal SW 9 mm	2000123
M12×250, hexagonal SW 9 mm	2000124
M12×300, hexagonal SW 9 mm	2000125
M12×350, hexagonal SW 9 mm	2000126
M12×400, hexagonal SW 9 mm	2000127

## Solar fastener

### For steel, timber and concrete substructures

Solar fasteners (stainless steel) for attaching the K2 mounting rails on roofs with trapezoidal sheet metal, corrugated fibre cement or corrugated sheet metal. Matching M10/M12 adapter plates are available separately.



### Steel: Solar fastener Ø 8.0 with M10×50 screw thread, E16 dome

Type	Item number
8×64 / 50, length 114 mm	1001491
8×80 / 50, length 130 mm	1002586
8×100 / 50, length 150 mm	1001636
8×125 / 50, length 175 mm	1001412
8×150 / 50, length 200 mm	1001134
8×160 / 50, length 210 mm	1000666
8×200 / 50, length 250 mm	1001751



### Steel: Solar fastener Ø 8.0 with M10×50 screw thread, FZD

Type	Item number
8×64 / 50, length 114 mm	1002218
8×80 / 50, length 130 mm	1001435
8×100 / 50, length 150 mm	1001400
8×125 / 50, length 175 mm	1001459
8×150 / 50, length 200 mm	1000985
8×160 / 50, length 210 mm	1004095
8×200 / 50, length 250 mm	1001838



**Timber:** Solar fastener Ø 8,0 mm  
M10×50/70 mm,  
metric thread  
E14 calotte or  
FZD sealing made of EPDM  
On request



**Concrete / aerated concrete:**  
Solar fastener Ø 8,0 mm  
M10×50/70 mm, metric thread  
E14 calotte or FZD sealing made  
of EPDM  
On request



## Standing seam clamps



Our seam clamps are used to fasten the K2 mounting rails onto standing seam roofs or rounded seams. We offer seam clamps for steel or aluminium roofs.

### K2 Round Seam Clamp

For Kalzip roofs with rounded seam ends  
Screw: M10  
Clamping screw: M8  
Sheet thickness: 3 mm  
Material: Stainless steel  
Item no. 2001853

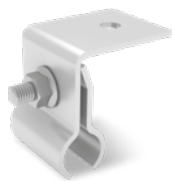

### S-5! Z-Mini-FL Round Seam

For Kalzip roofs with rounded seam ends  
Slot: 11×22  
Clamp: Grub screw  
Material: Aluminium  
Item no. 1000888



### K2 Standing Seam Clamp

For standing seam metal roofs  
Screw: M10  
Clamping screw: M8  
Sheet thickness: 2.5 mm  
Material: Stainless steel  
Item no. 2001712



### S-5! E-Mini-FL Standing Seam

For Kalzip standing seam metal roofs  
Slot: 11×22  
Clamp: Set screw  
Material: Aluminium  
Item no. 1001052



### Rib-Roof Evolution Round Seam

For Rib-Roof Evolution seam metal roofs with rounded seams  
Screw: M10  
Clamping screw: M8  
Material: Aluminium  
Item no. 2002226



### Rib-Roof Speed 500 Standing Seam

For Rib-Roof Speed 500 standing seam metal roofs  
Screw: M10  
Clamping screw: M8  
Material: Aluminium  
Item no. 2002225



### Rib-Roof 465 Standing Seam

For Rib-Roof 465 standing seam metal roofs  
Screw: M10  
Clamping screw: M8  
Material: Aluminium  
Item no. 2002118

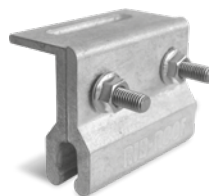

# Accessories

▶ Module clamps	22
▶ Self-drilling wood screw, flange head	24
▶ Self-tapping hexagon screw with sealing washer	24
▶ T-bolt and flange nuts with serration	24
▶ MK2 slot nuts with assembly clip	24
▶ Self-drilling wood screw, flange head, underhead secondary thread	25
▶ Self-drilling wood screw, countersunk head	25
▶ Screw anchor, Multi Monti	25
▶ CrossRail/SingleRail End Caps	26
▶ SolidRail End Caps	26
▶ Lightning protection clamp Multi Sets	26
▶ TerraGrif equipotential bonding	26
▶ Pad spacer	27
▶ Height Compensator for aluminium roof hooks	27
▶ Cable clips	27

## Module clamps

Our module clamps can be easily mounted to any K2 rail. The MK2 slot nut automatically locks in place and can be moved in the rail by pressing lightly on the Allen bolt.

### Module middle clamps XS

Module frame height / description	Item number
30-33 mm/M8×50, aluminium mill finish	1005156
30-33 mm/M8×50, black anodised	1005157
39-44 mm/M8×60, aluminium mill finish	1004908
39-44 mm/M8×60, black anodised	1005159
45-48 mm/M8×65, aluminium mill finish	1005143
45-48 mm/M8×65, black anodised	1005160
49-50 mm/M8×70, aluminium mill finish	1004407
49-50 mm/M8×70, black anodised	1005161

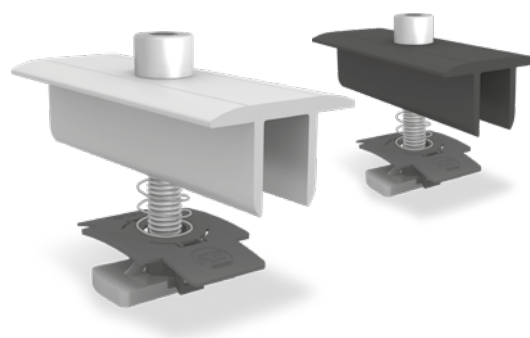

## Universal module clamps OneMid and OneEnd

These module clamps are suitable for the most common module frame heights of 32-42 mm. Compatible with SingleRail, CrossRail, SpeedRail, MultiRail, SolidRail plus S- and D-Dome.

Description	Item number
OneMid, mid clamp, aluminium mill finish	2002515
OneMid, mid clamp, black anodised	2002588
OneEnd, end clamp, aluminium mill finish	2002514
OneEnd, end clamp, black anodised	2002589

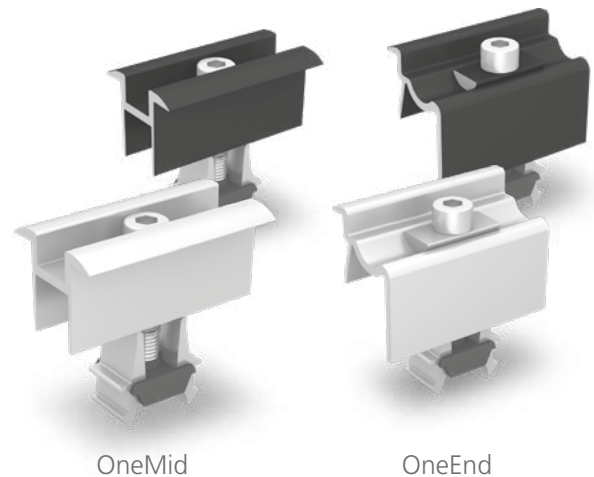

## Module end clamps

Module frame height / description	Item number
30-31 mm/M8x30, aluminium mill finish	1005345
30-31 mm/M8x30, black anodised	1005347
42-44 mm/M8x35, aluminium mill finish	1005291
42-44 mm/M8x35, black anodised	1005295
45-47 mm/M8x40, aluminium mill finish	1005171
45-47 mm/M8x40, black anodised	1005270
48 mm/M8x40, aluminium mill finish	1005292
48 mm/M8x40, black anodised	1005296
49-50 mm/M8x45, aluminium mill finish	1005172
49-50 mm/M8x45, black anodised	1005271

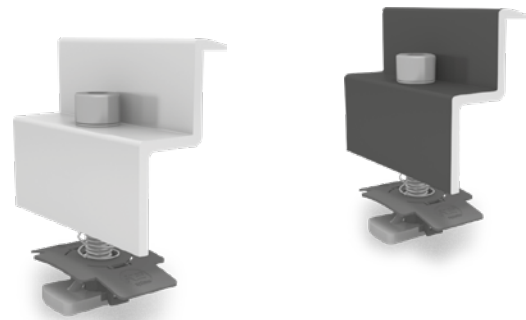

## Module clamps for laminate modules

Module middle clamps for fastening laminate modules; approved for First Solar and Calyxo thin-film modules; small module spacing. Material: Aluminium mill finish, EPDM

Please note: For additional anti-slip protection the K2 Slideguard is suitable for vertical mounting of laminate modules with a glass thickness of 6-9 mm. Material: Stainless steel 1.4016, EPDM

Type / accessory	Item number
Module middle clamp	1003157
Module end clamp	1003158
Slideguard	1005828



# Accessories

## Self-drilling wood screw, flange head

Self-drilling wood screw with flange head (Topix) and star socket (Torx) from Heco. With European Technical Assessment (ETA) approval. Material: Stainless steel A2, matches TX 25/40 screwdrivers

Type	Item number
6x80	1005837
6x100	1004978
8x80	1000642
8x100	1000656
8x120	1001525
8x160	1002366
8x180	1002367



## Self-tapping hexagon screw with sealing washer

Approved for steel sheets with a minimum thickness of 0.5 mm and aluminium sheets with a minimum thickness of 0.7 mm (MiniRail 0.5 mm). Material: Stainless steel A2, EPDM

Type	Item number
<b>Drilling screw,</b> SW 8, sealing washer Ø 16 mm 6 x 25 mm	1000212
6 x 36 mm	1001622
<b>Thin sheet screw, virtually chip-free,</b> SW 8, sealing washer Ø 16 mm 6 x 25 mm	1005207
6 x 38 mm	1005193



Drilling screw



Thin sheet screw

## T-bolt and flange nuts with serration

T-bolt for use in the lower chamber of K2 SolidRail rails. Head form: 28/15; head dimensions: 22.5 x 10.5 x 4 mm Material: Stainless steel A2 1.4301

Type	Item number
M10x20	1000637
M10x30	1000041
M8x20/30	1000614/1000368



The flanged nut with serration (similar to ISO 4161) prevents it from loosening.

Material: Stainless steel A2

Type	Item number
M8	1000043
M10	1000042

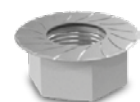

## MK2 slot nuts with assembly clip

The MK2 slot nuts can be used at any point on the K2 rails. They automatically lock in place. Subsequently, they can easily be moved about in the rail by pressing them lightly.

Material: Stainless steel 1.4301 + PA or aluminium + PA; Item number: 1001643 (stainl. steel) 2000034 (aluminium)





## Self-drilling wood screw, flange head, underhead secondary thread

Self-drilling wood screw (Heco) with flange head (Topix) and star socket (Torx). With building approval. For mounting with over-rafter insulation. Fixes the counterbattens in place using a second screw thread under screw head. Material: Stainless steel A2; matches TX 40 screwdrivers



Type	Item number
8 x 240	1003437
8 x 300	1003438
8 x 360	1003439

## Self-drilling wood screw, countersunk head

Self-drilling wood screw with countersunk head (Heco). With building approval. Material: Stainless steel A2; matches TX 25 screwdrivers



Type	Item number
6 x 120	1004443
6 x 160	1001607

## Screw anchor, Multi Monti

Multi Monti screw anchor (Heco) for fastening to concrete; min. borehole depth 40 mm. Steel surface: galvanised and blue passivated, head diameter 17 mm, nominal bore diameter 6 mm  
Material: galvanised steel  
Drive: TX 30



# Accessories

## CrossRail/SingleRail End Caps

End caps for K2 CrossRail and SingleRail.  
Material: Glass fibre reinforced polyamide

Type	Item number
CrossRail/SingleRail 36	1004767
CrossRail 48	1004768

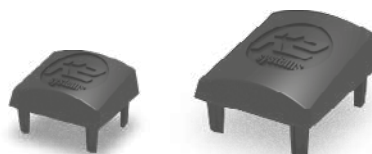

## SolidRail End Caps

End caps for K2 SolidRail.  
Material: Glass fibre reinforced polyamide

Type	Item number
Light	1004765
Medium	1004766
Alpine	1005053

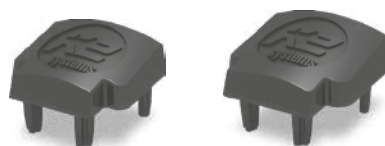

## Lightning protection clamp Multi Sets

Lightning protection clamp for clamping lightning protection cables with Ø 8 mm.  
For universal use as a T cross, parallel and impact clamps. Material: aluminium

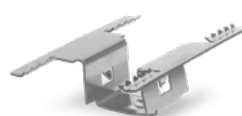

Image	Type	Components	Item number
	Lightning protection clamp Multi Alu 8 mm Set	<ul style="list-style-type: none"> <li>Lightning protection clamp Multi (1003151), aluminium</li> <li>Slot nut (1001643), stainless steel, PA</li> <li>Washer (8,4 × 20 × 1.2 mm), stainless steel A2</li> <li>Allen Bolt (M8×30), stainless steel A2</li> </ul>	2002473
	Lightning protection clamp 8mm Double Set	<ul style="list-style-type: none"> <li>2× lightning protection clamps Multi (1003151), Aluminium</li> <li>Hexagon flange nut with serration M8 (100043); stainless steel A2</li> <li>2× washers (8.4 × 20 × 1.2 mm), stainl. steel A2</li> <li>Allen Bolt (M8×40), stainless steel A2</li> </ul>	2002474

## TerraGrif equipotential bonding

Equipotential bonding between module and rail.  
Material: Stainless steel

Type	Item number
TerraGrif K2MI Landscape/Portrait	2002649
TerraGrif K2PA 32 Landscape	2000055
TerraGrif U17 Portrait	2000056
TerraGrif K2SZ Landscape/Portrait	2001881



K2MI



K2PA



U17

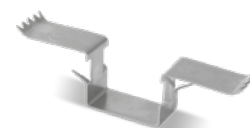

K2SZ

## Pad spacer

PA spacer shim to compensate for height differences when mounting K2 roof hooks with screw threads and K2 rails (except SolidRail).

Any number of spacer shims can be stacked to provide customised height.

Material: Glass fibre reinforced PA

Material thickness: 2 mm

Item no.: 1002361



## Height Compensator for aluminium roof hooks

To compensate for batten differences so that the bracket height of each roof hook can be individually adjusted.

Material: Aluminium

Material thickness: 4 mm

Item no.: 2002332



## Cable clips

Type	Item number
<b>Cable Manager</b> Solar Cable Manager with connecting possibility for outdoor-installation L x W: 200 x 4.6 mm	2002870
<b>Omega Cable Clip</b> Suitable for CrossRail, SingleRail, SolidRail, S-Rock 4 cables with Ø 6 mm Material: Polypropylene with UV stabiliser	1005394
<b>Cable Routing Clip</b> Suitable for clamping in module frames with a thickness of 1.5-2.5 mm and S-Rock 4 cables with Ø 6 mm Material: Spring steel	2002322



Cable Manager

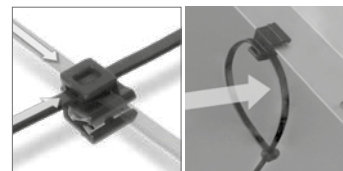

Omega Cable Clip



Cable Routing Clip

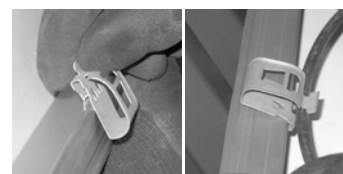

## Other K2 systems

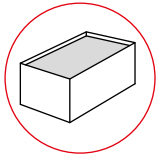

▶ Flat roof systems

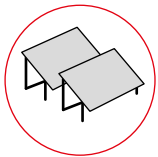

▶ Ground mounted systems

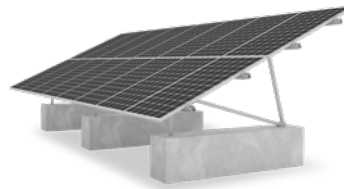

### K2 Systems GmbH

Industriestraße 18  
71272 Renningen  
Germany

Tel. +49 (0) 7159-42059-0  
Fax +49 (0) 7159-42059-177

info@k2-systems.com  
www.k2-systems.com